

England Shaker Hampton Style Cabinet

Specification – VAN-ENG-XX-SIZE

- Suitable Bench Top
 - Aries Ceramic Basin (AR)
 - Stone & Undermount Basin (SU)
 - Stone for Bench Top Basin (ST)
- Size for Cabinet Only – Blitz Vanity only available for Wall Hung.

600mm

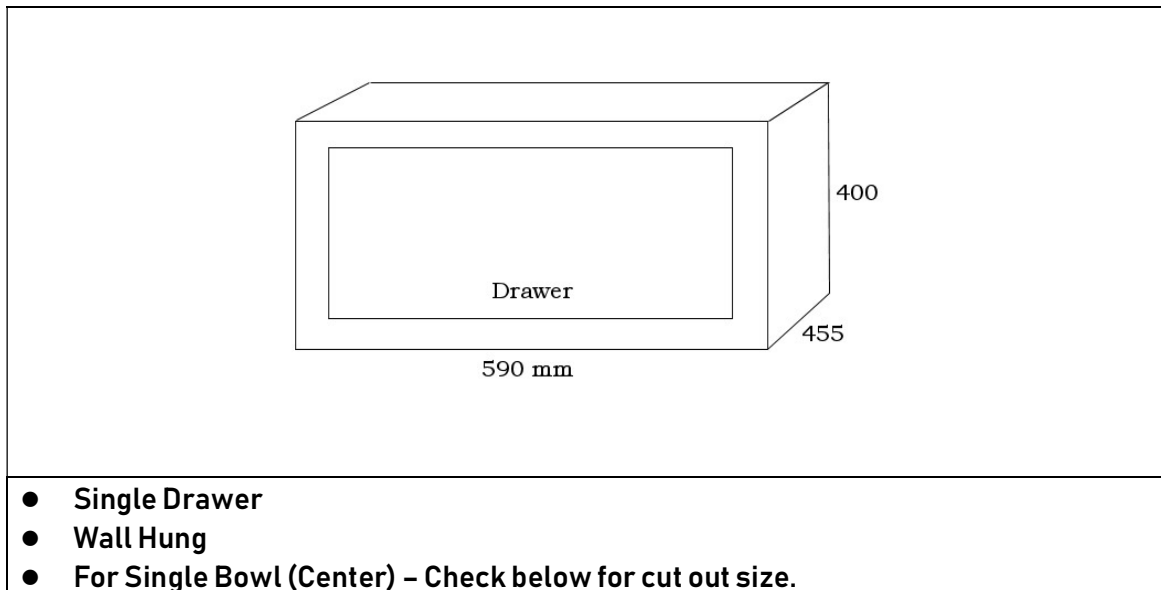

750mm

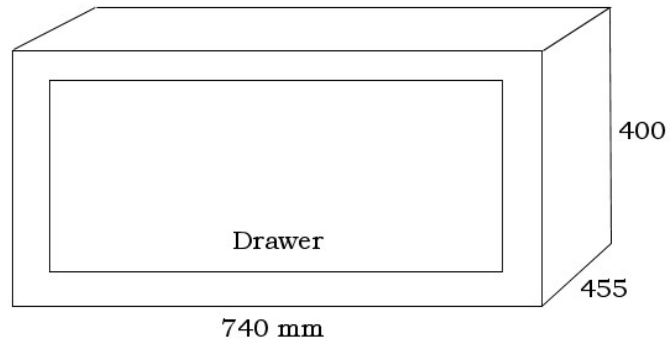

- Single Drawer
- Wall Hung
- For Single Bowl (Center) - Check below for cut out size.

900mm

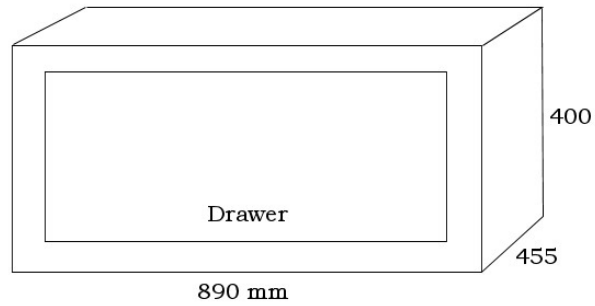

- Single Drawer
- Wall Hung
- For Single Bowl (Center) - Check below for cut out size.

1200mm

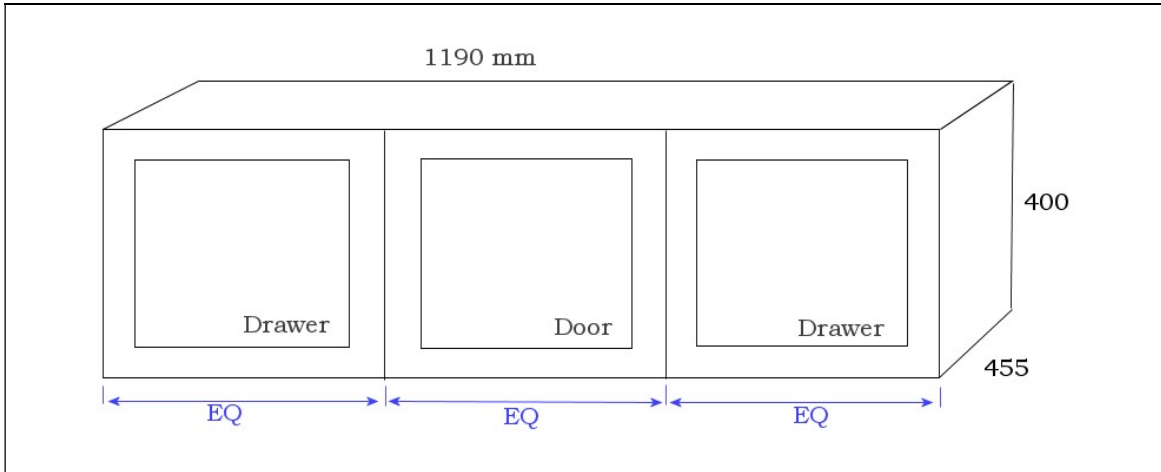

- Two Drawers & One Door in the Middle
- Wall Hung
- For Single Bowl (Center) – Check below for cut out size.

1500mm

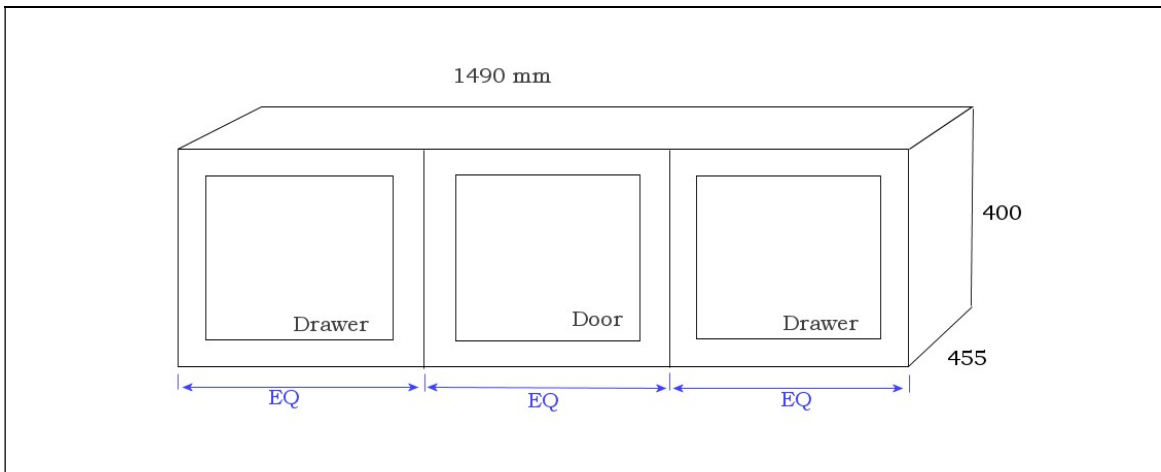

- Two Drawers & One Door in the Middle
- Wall Hung
- For Single Bowl (Center) – Check below for cut out size.

1800mm

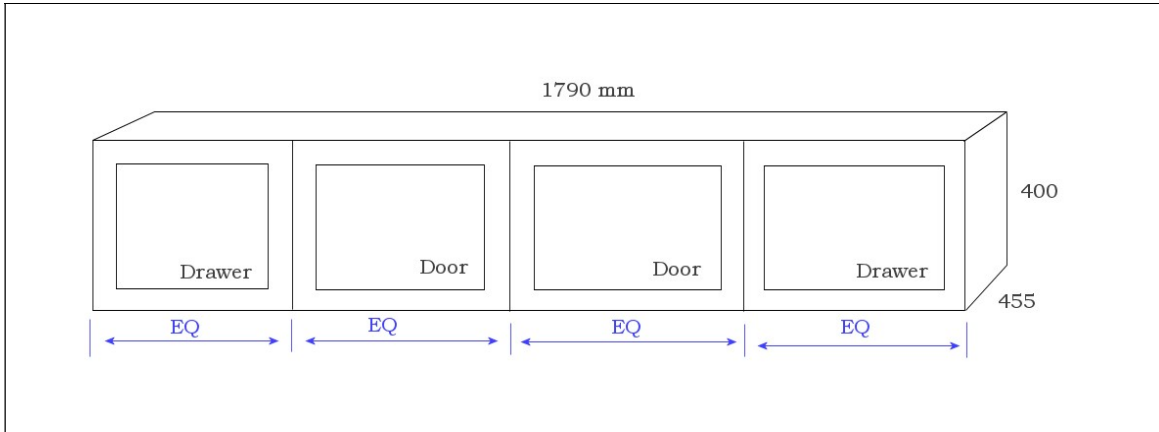

- **Two Drawers & Two Doors in the Middle**
- **Wall Hung**
- **For Single Bowl (Center) & Double Bowls – Check below for cut out size.**

Drawer cut out size

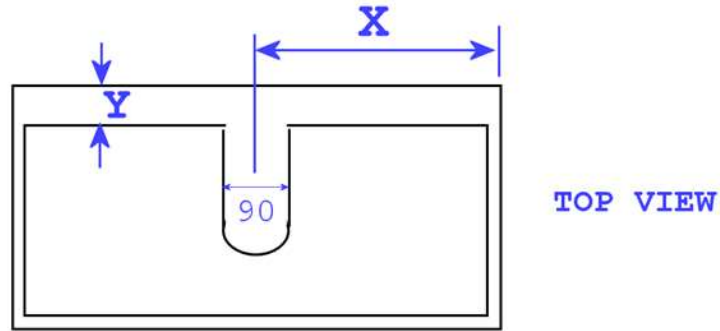

Y: 68mm to the back panel | 85mm to the wall

Cabinet Size	X
600mm Single	300mm
750mm Single	375mm
900mm Single	450mm

Standard Layout for Single Bowl (Center) Vanity with One Drawer



Y: 68mm to the back panel | 85mm to the wall

Top View

Standard Layout for 1200 mm & 1500 mm Single Bowl (Center) and Double Bowls Vanity with Two Drawers & One Door

*** Double Bowl Layout only Suitable for Bench Top Basin**

Top View

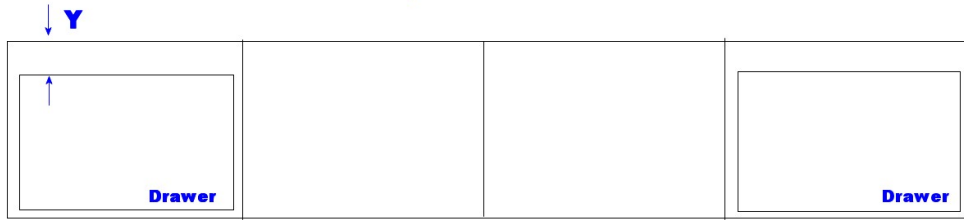

Y: 68mm to the back panel | 85mm to the wall

Standard Layout for Single & Double Bowls Vanity with Two Drawers & Two

Doors in 1800 mm